

USER'S GUIDE m² AAD



CONTENT

	Warning	2	6.3	Switching device off	20
1.	Introduction	4	6.4	Switching device to UP-mode	20
2.	Construction	5	6.5	Switching device to DOWN-mode	21
2.1	Individual Device Parts	5	6.6	Switching device to X-mode	22
2.2.1	Processing Unit	5	6.7	Information in the device memory - MENU	22
2.2.2	Control Unit	6	6.7.1	MENU display description	22
2.2.3	Cutter	6	6.7.2	Sequence to display MENU	24
3.	Function	7	6.8	QuickCard switch-on sequence	25
3.1	Function Principal	7	6.9	QuickCard switch-off sequence	26
3.2	Functional Modes	7	7.	Maintenance	27
3.2.1	STANDARD-mode	8	7.1	Cutter Replacement	27
3.2.2	UP-mode	9	7.2	Filter Replacement	28
3.2.3	DOWN-mode	10	7.3	Battery	28
3.2.4	X-mode	11	7.4	Yearly Inspection	29
3.3	Altitude safety zone of the m² device	11	8.	Securing closing loop in washer	30
3.4	Function of m² at use in a pressurized aircraft	12	9.	Error Reports	31
3.5	Altitude lock	12	10.	Technical Data	32
3.6	Landing in water	12	10.1	Basic Technical Data	32
4.	Safety Device Versions	13	10.2	Total Lifetime of m² and Batteries	32
4.1	m² EXPERT	13	10.3	Cutter Lifetime	32
4.2	m² STUDENT	13	11.	Important Principles	33
4.3	m² TANDEM	14	12.	Warranty	34
4.4	m² SPEED	14	13.	X-ray Card	35
5.	Installation	16	14.	Disclaimer	36
6.	Control	19			
6.1	Control Principals	19			
6.2	Switching device to STANDARD-mode	19			

Warning

Skydiving is a dangerous activity which can result in serious or even fatal injury. Training and experience are required in order to reduce such risk. Using the m² safety device during skydiving can significantly reduce the risks. Never solely rely on the m², since it is not the primary tool for opening of your parachute. Remember the m² is an electronic device and, just like other equipment, it can fail. In the case of some collisions, the m² may cause death. Read the instruction manual thoroughly prior to using the device. The device is not designed for PARAGLIDING, PARASCENDING, PARASAILING, or BASE JUMPING. The failure-free function of the m² cannot ensure the correct function of the parachute system, i.e. the harness with the container, the reserve parachute, and the accessories. The m² device is only responsible for cutting a closing loop of a reserve parachute which is properly pulled through the cutter!!!

The specified activation altitude of the m2 is based on a skydiver in a stable body position. If the skydiver is in another orientation, or unstable, this may result in pressure changes that cause the m2 to activate above the specified altitude. To avoid premature activation of the m2 the skydiver should be in a stable body position and comply with the recommended altitudes for main canopy deployment.

In addition, the skydiver should be aware that it is possible to exceed the specified limits under canopy and cause the m2 to activate. The Gravity Index is designed to show you how close you are to activation of the device under canopy, and we recommend that users become familiar with this feature (see page 23).

I. Introduction

Thank you for buying the AAD **m²**, and we hope you will never find yourself in a situation where you need it. Simply switch the **m²** device on in the morning prior to the first jump and it will guard your safety without any further bother.

The Automatic Activation Device „AAD“ is an automatic electronic safety device. The **m²** device continuously checks that the skydiver is not too close to the ground without an open and functional parachute. It detects a skydiver's falling speed and altitude. If the **m²** assesses the situation as hazardous for the skydiver, the cutter automatically cuts the closing loop of the reserve parachute, which starts the process of opening the reserve parachute. It is designed and manufactured based on the latest findings focused on sports skydiving, and its function fully meets the demands of the current skydiving sport.

Professional designers, who are also excellent skydivers, have contributed to its development. The device is available in **m² EXPERT**, **m² STUDENT**, **m² TANDEM** and **m² SPEED** versions. Upon switching on the **m²** it works fully automatically, without user intervention.

The **m²**'s main advantages are:

- ultra low power design – no need for battery replacement throughout its lifetime
- 15-year lifetime without servicing required by the manufacturer
- compact smooth rounded metal construction
- minimal thickness of the body, control unit, as well as the cutter
- water resistant to 2 m in salt or fresh water
- simple operation and many sophisticated extra features



2. Construction

2.1 Construction

The **m²** is constructed in order to comply with the requirements for resistance and correct function in all situations. It does not limit the skydiver in any way. It operates with minimum requirements for energy consumption, which enables it to retain a sufficient energy source capacity for its entire service life without the necessity of battery replacement.

It is built into a harness in minimum space and allows the skydiver to open the reserve parachute primarily with the manual release handle.

2.2 Individual Device Parts

The **m²** consists of a processing unit in which the battery is stored, a processor, an electronic circuit and a pressure sensor. The processing unit is tightly connected via cable to the control unit, with a multi-function display and control button. The cutter is connected to the processing unit body via a connector as a removable device part.

Never break or pull the control unit cable or the cutter cable!!!

2.2.1 Processing Unit

The body of the processing unit is made of aluminum alloy with a finished surface. The front face of the processing unit shows the **m²** logo, and on the back is the identification label. The filter is placed between the cable penetrations on the top. The whole body is sealed watertight.



On the identification label is the following information:

- **SN** (serial number), unique production number
- **MFD** (Manufacture Date), year and month of manufacture
- **m² AAD**, commercial designation
- **Made in Czech Republic** and **EU**, country of origin
- logo and other required markings for this type of a device

2. Function

2.2.2 Control Unit

The body of the control unit is made of stainless steel and is connected to the processing unit by a flexible cable. The control unit has a display for various icons, the control button and the label specifying the device version. The label also includes the units - meters or feet. If the label indicates „meter“, all of the entered and displayed altitudes are in meters. If the label indicates „feet“, all of the altitudes entered and displayed are in feet.

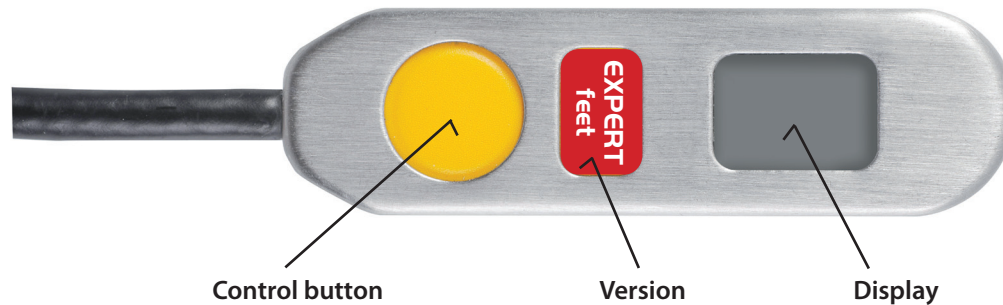

The control button should be pressed with the pad of your finger only, never use your nail or other sharp object!!!

2.2.3 Cutter

The cutter is made from stainless steel and ensures cutting of the reserve parachute closing loop, if necessary.

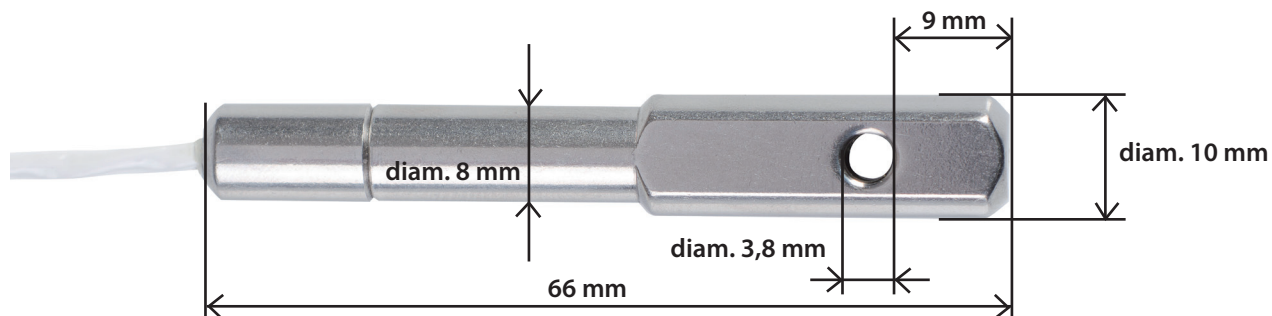

Its shape allows firm fixation between the reserve parachute flaps and prevents rotation of the cutter body around its longitudinal axis. It is very scratch resistant. It is connected to the main unit by a flexible cable and connector. The connector is completely inserted into the processing unit and is secured with a locking screw to prevent accidental removal.

3. Function

3.1 Function principal

The **m²** device is an electronic safety device, operating on the principal of pressure sensing. The primary tool for determining the altitude and the falling speed is a pressure sensor. The calculation of the altitude is made based on the difference of two atmospheric pressures: the current altitude pressure and the landing area „GROUND ZERO“ pressure. The landing area pressure is measured and set when the device is switched on, during calibration. This pressure is automatically adjusted to barometric pressure changes during the day without the need of user intervention. The **m²** checks the ambient barometric pressure every 32 seconds and evaluates possible aircraft takeoff. If takeoff is confirmed, the **m²** will start checking the skydiver's altitude and his falling speed. The pressure sensor monitors the actual atmospheric pressure 8x per second during free fall; the received information is evaluated by means of a microprocessor and sophisticated software and recalculated to the real falling speed and actual altitude. Thanks to this, the **m²** device is able to use the cutter to cut the closing loop on the reserve parachute and initiate its opening upon meeting the preset limits of the falling speed in combination with the altitude above landing area. The device is activated only upon meeting the set limits which are different for the individual **m² EXPERT, m² STUDENT, m² TANDEM or m² SPEED.**

The device is responsible solely for cutter activation as per specified limits, and for cutting the closing loop of the reserve parachute. It is not responsible for the correct and full function of the whole harness system with the container, reserve parachute, and other accessories!!!

3.2 Function Modes

The **m²** was designed to be an extremely simple safety device to use. Most users just want to switch the AAD on before the first jump and no longer worry about it. In addition to the standard mode, which the user will use the most, the **m²** software also enables other functional modes: a mode for landing above the aircraft's take off, a mode for landing below the aircraft's take off and X mode, for the temporary change of parameters. Changing the mode changes the device parameters. Therefore, always think twice about what you are doing. The mode is selected during the **m²** activation sequence. After manual or automatic device switch off, the default STANDARD mode is set. The current active mode is displayed by an icon on the display.



STANDARD-mode



UP-mode



DOWN-mode



X-mode

UP- mode or DOWN-mode are used if the landing location is higher or lower than the take-off location. The **m²** allows the setting of various altitudes for the landing location within the range of +/- 990 m (+/- 2,990 ft), and it is set in increments of 10 m (10 ft). X-mode allows non-standard device override.

3. Function

3.2.1 STANDARD-mode

The STANDARD-mode is used always when the skydiver starts and lands at the same location, same drop zone and doesn't need to change the device parameters. Landing location is at the same elevation above sea level as the aircraft take-off location. The display

shows the  icon. When using this mode, always switch the device on at the landing location.

The m^2 device requires for the aircraft to ascend up to at least 40 m (130 ft) in order for correct start detection and to remain above this altitude until the skydiver's jump. Further, depending on the device version, it is necessary to exceed the preset altitude lock by either 450 m (1,475 ft), or 900 m (2,950 ft) to unlock the device.

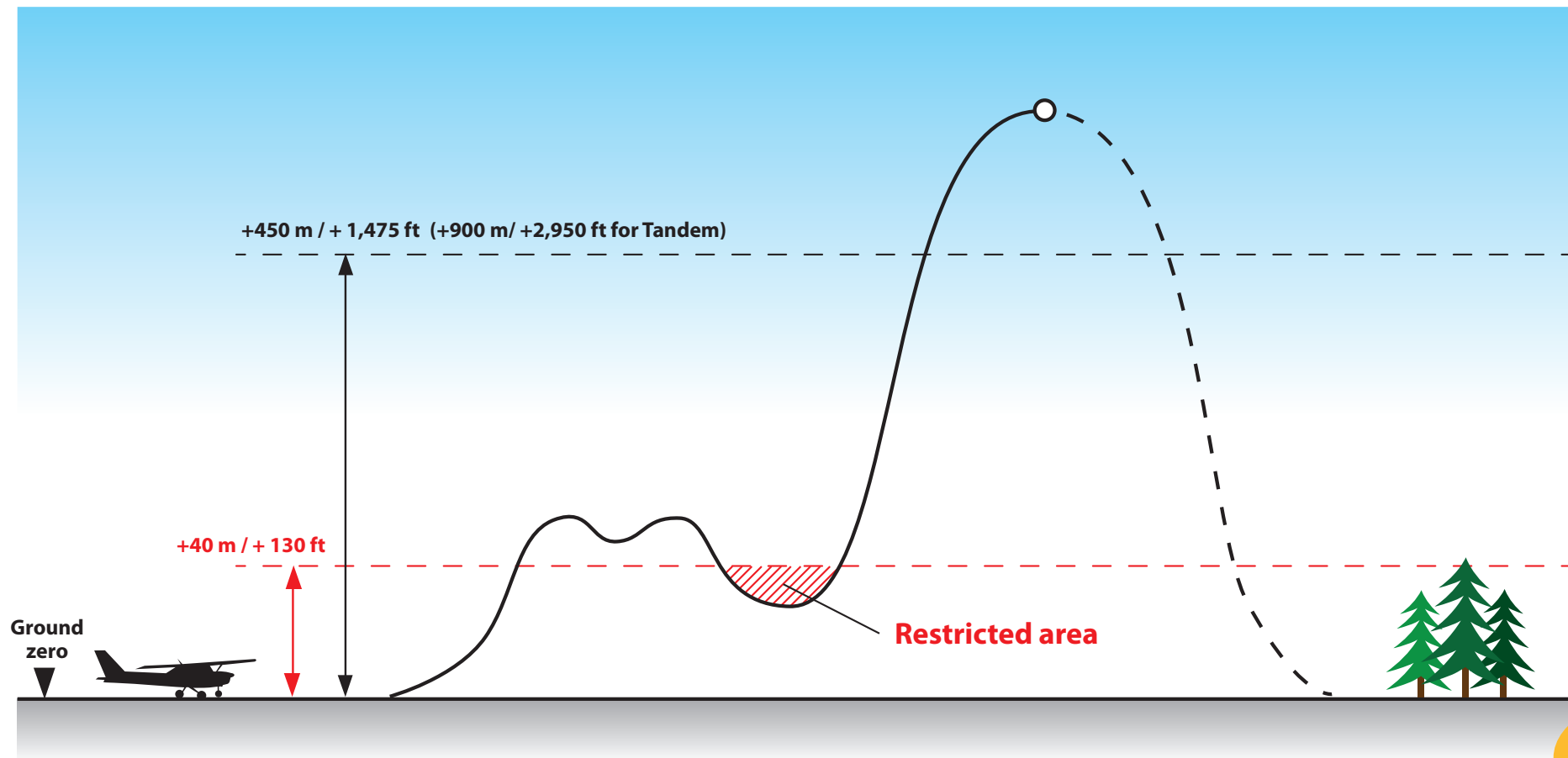

3. Function

3.2.2 UP-mode

The UP-mode is used when the landing location is higher than the aircraft take-off location. The display shows the  icon. When using this mode, switch the device on at the aircraft take-off location.

For the correct functioning of the m^2 , it is necessary to preset the elevation difference between the landing and take-off location altitude. The numeric value of how much higher the skydiver will land compared to aircraft take-off must be entered. In this case, the altitude lock depends on the landing location, i.e. as per version 450 m (1,475 ft) or 900 m (2,950 feet), plus the specified altitude difference. In such a case, the m^2 device requires for the aircraft to immediately ascend up to at least 40m (130 ft) above the take-off location in order to

allow correct start detection, and to remain above this altitude. Upon reaching and exceeding this preset altitude of plus 40 m (130 ft), the aircraft must remain above this altitude level until the skydiver's jump. Upon landing with the preset altitude, the device automatically switches off. If you do not reach the preset altitude, switch the device off manually. Switch on the device prior to the next jump. You will be provided with failure-free calibration and functioning of the m^2 device.

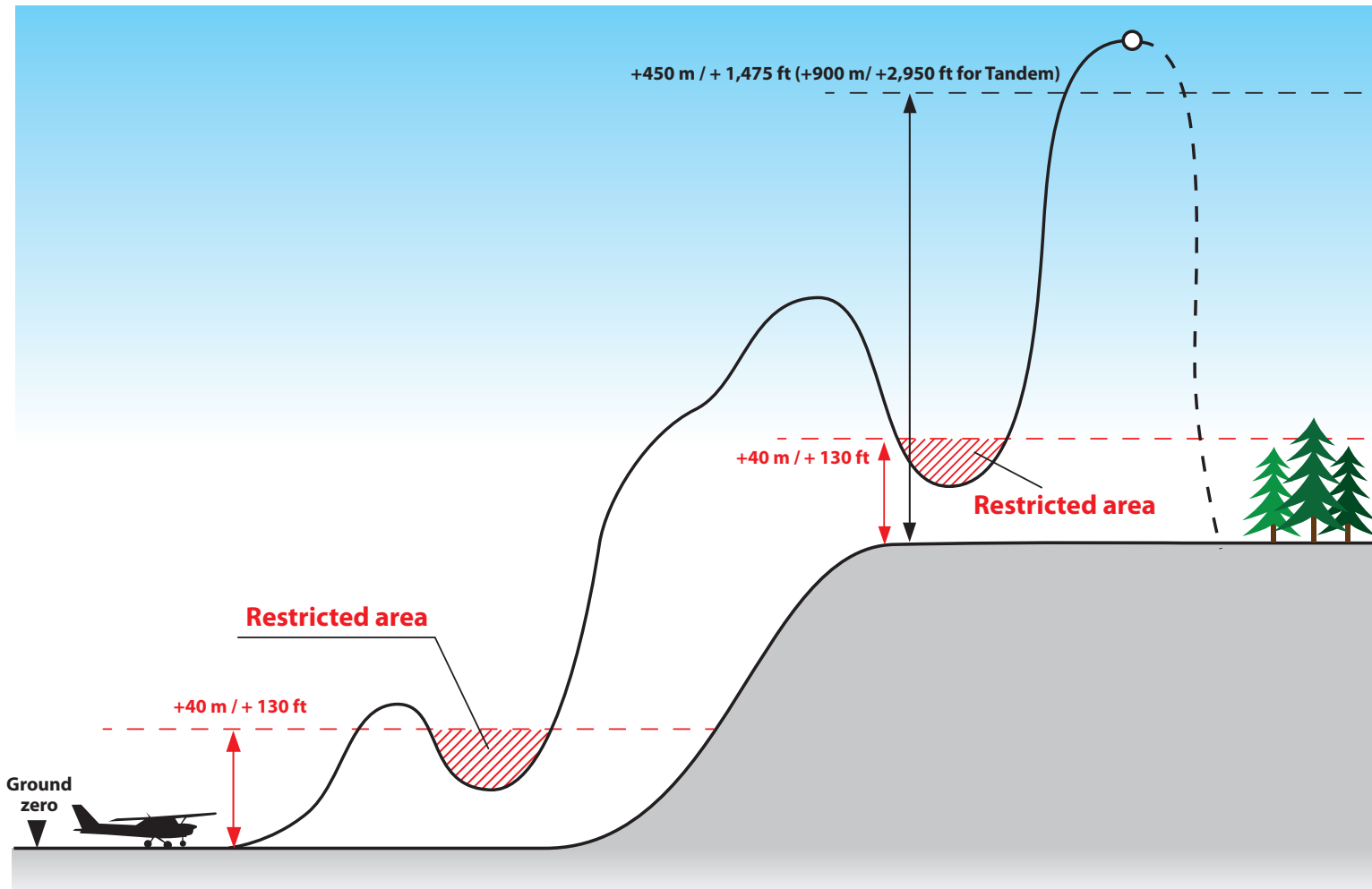

3. Function

3.2.3 DOWN-mode

The DOWN-mode is used when the landing location is lower than the aircraft take-off location. The display shows the  icon. When using this mode, switch the device on at the aircraft take-off location.

For the correct functioning of the m^2 , it is necessary to preset the elevation difference between the altitude of the take-off and landing locations. The numeric value of how much lower the skydiver will land compared to aircraft take-off must be entered. In this case, the altitude lock depends on the landing location, i.e. as per version 450 m (1,475 ft) or 900 m (2,950 feet), minus the specified altitude difference. In such a case, the m^2 device requires for the aircraft to immediately ascend up to at least 40 m (130 ft) above the take-off location in order to allow correct start detection, and to remain above this altitude for at least 90 seconds. After 90 seconds, it is possible to descend even lower than the take-off altitude; nevertheless, you **must not** descend under the preset landing location altitude plus 40 m (130 ft). Upon landing with the preset altitude, the device automatically switches off. If you do not reach the preset altitude, switch the device off manually. Switch on the device prior to the next jump. You will be provided with failure-free calibration and functioning of the m^2 device.

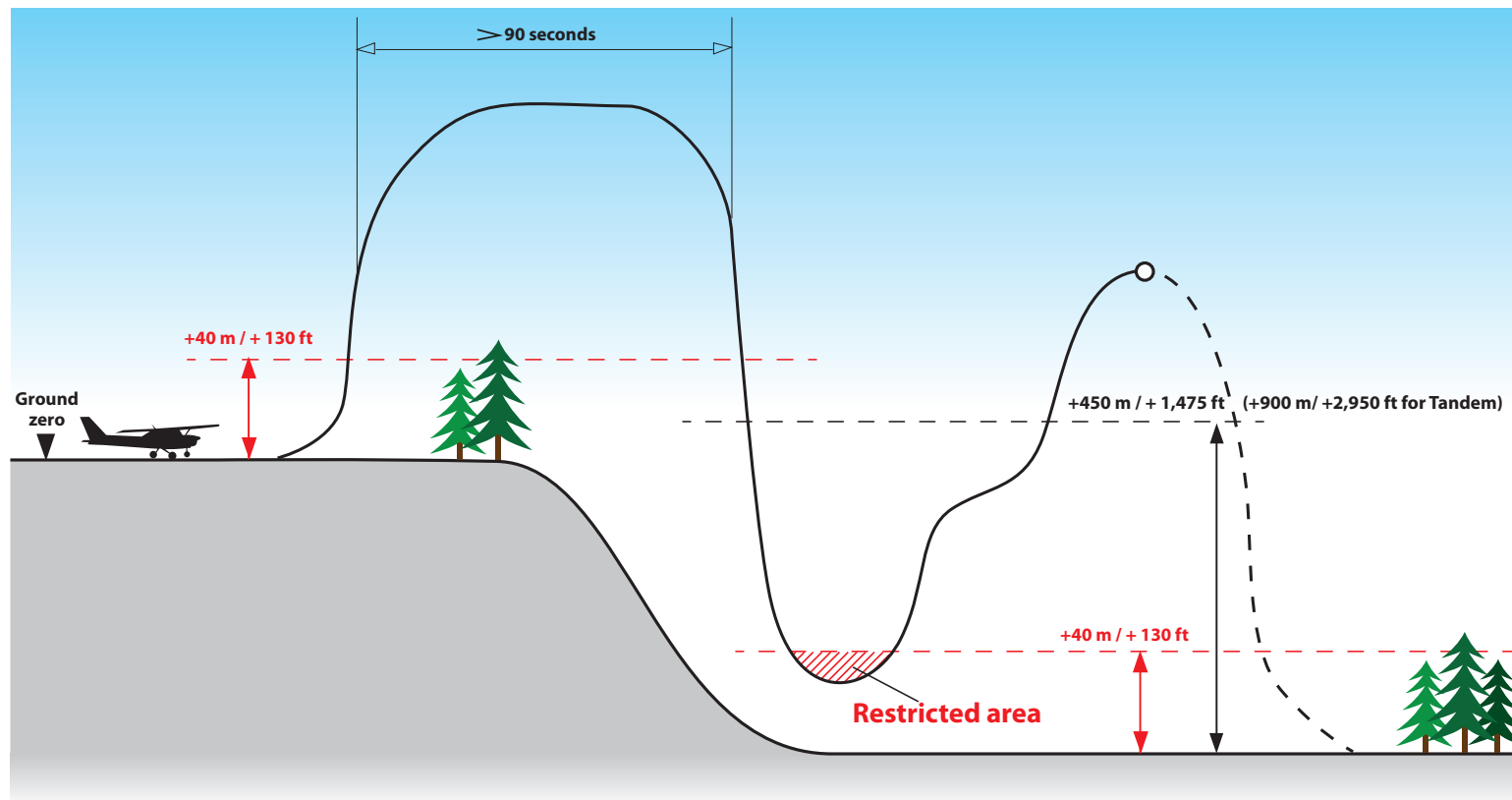

3. Function

3.2.4 X-mode

(Only for devices with firmware 2xxx and higher)

X-mode is suitable for use when the take-off location and landing location (drop zone) are the same and a change in the device parameters is not needed. The function is the same as for the STANDARD-mode, what changes are the device parameters. The landing

location is at the same elevation above sea level as the aircraft take-off location. The display shows the  icon. When using this mode, always switch the device on at the landing location.

Device parameters change as follows:

STANDARD-mode		X-mode
m ² STUDENT	⇒	will function as m ² EXPERT
m ² EXPERT	⇒	will function as m ² SPEED
m ² TANDEM	⇒	N/A

The possibility to change parameters is firmly preset for each version. This change will be valid until the device is switched off. The reason for the firm preset is common sense and safety.

In some situations, X-mode may be very convenient, however, use it with great caution!

3.3 Altitude protection zone of the m² device – “! Important for the aircraft pilot !”

The altitude protection zone of the m² device consists of the first 40 m (130 ft) of elevation above the aircraft take-off location. It is necessary to exceed the 40 m (130 ft) as fast as possible at a steady ascent. At 40 m (130 ft), the m² device detects the aircraft take off and switches from “stand-by” mode to “fly” mode. Upon exceeding the 40 m (130 ft) protection zone, the device must not drop under this altitude until the dive is completed. **The only exceptions are in those cases when the skydiver’s landing zone is located at a different altitude than the aircraft take-off location.** For such cases, carefully read the UP-mode or DOWN-mode chapters, where the specified m² functions are detailed and illustrated with diagrams.

3. Function

3.4 Function of the m² in a pressurized aircraft

The m² device can be used in pressurized aircraft providing the conditions below are observed.

The ambient atmospheric pressure (outside the aircraft) must be maintained inside the aircraft up to 450 m (1,475 ft) above the aircraft take-off location for the m² EXPERT, m² STUDENT and m² SPEED device versions and 900 m (2,950 ft) for the m² TANDEM version. At the specified altitudes, the device will be unlocked, which will be indicated by the disappearance of the centre line on the control unit. Once the altitude lock unlocks, the aircraft can be pressurized. The aircraft must not be pressurized to a pressure higher than the ambient atmospheric pressure adequate for an altitude of 450 m (1,475 ft) or 900 m (2,950 ft). If there are devices present in the aircraft with preset altitude locks for 450 m (1,475 ft) and 900 m (2,950 ft), the pilot must pressurize the aircraft for ambient atmospheric pressure at 900 m (2,950 ft). If the specified limits are not observed, the device may fail.

3.5 Altitude Lock

The altitude lock is preset in the device as the fixed value of the altitude above ground at which the device automatically unlocks to activate the cutter during the aircraft ascent. The cutter activation is enabled only after exceeding this altitude. The device will be unlocked, which will be indicated by the disappearance of the centre line on the control unit. This is a small but very important interaction with the user.

Before unlocking:  After unlocking: 

In the aircraft does not exceed the altitude of the altitude lock, the m² will not activate the cutter, even if all the other activation parameters are met. With the aid of the indication of altitude lock release, the user can easily check the correct function of the device in the aircraft with an altimeter, or the instructor can perform a quick m² function check before the student jumps. If the center line is not present, the device is fully functional and ready for a jump.

3.6 Landing in water

The m² device can be used for landing in water, salt or fresh. The processing unit and the control unit, as well as the cutter, are waterproof to a depth of 2 m (6.5 ft) under the surface for up to 24 hours. The processing unit contains a filter that has to be changed upon contact with water. If it lands in the water but water doesn't get to the filter, replacement is not necessary. For the procedure of how to replace the filter, see the Maintenance chapter. We recommend having the filter changed by your rigger. After the filter is replaced, check the altitude lock release in the aircraft to find ensure the filter is 100% permeable and fully functional.

4. Safety device versions

4.1 m² EXPERT

The m² EXPERT is the most commonly used version of the device. It is designated for experienced skydivers. Activation occurs if the altitude above the landing area is below 270 m (885 ft) and the falling speed is over 35 m/s-1 (78 mph). The altitude lock is 450 m (1,475 ft). Activation will not occur under an altitude of 100 m (328 ft). Therefore, the activation zone is in the range between 270 m and 100 m (885 ft and 330 ft) above the landing location



If you are using a high performance parachute, check the GRAVITY index!!!

4.2 m² STUDENT

The m² STUDENT version is designated for parachute gear for basic student training and AFF. The expected surface load of the main canopy is less than 1.0 lb/ft. Activation occurs if the altitude above the landing area is below 330 m (1,085 ft) and the falling speed is over 20 m/s-1 (45 mph), or if the altitude above the landing location is less than 200 m (660 ft) and falling speed is over 13 m/s-1 (29 mph) (*1). The altitude lock is 450 m (1,475 ft). Activation will not occur under an altitude of 60 m (195 ft). Therefore, the activation zone is in the range between 330 m and 60 m (1,085 ft and 195 ft) above the landing location.

**It is possible to reach a speed of 13m/s (29 mph) on a fully functional parachute!!!
If the student does not jump from the aircraft and returns for the landing, always switch off the m2 STUDENT. If this is not possible, the aircraft must not descend faster than 13m/s (29 mph).**



(*1) (Only for devices with firmware 2xxx and higher)

4. Safety device versions

4.3 m² TANDEM

The m² TANDEM version is designated for tandem gear. Activation occurs if the altitude above the landing area is below 610 m (2,000 ft) and the falling speed is over 35 m/s-1 (78 mph). The altitude lock is 900 m (2,950 ft). Activation will not occur under an altitude of 100 m (330 ft). Therefore, the activation zone is in the range between 610 m and 100 m (2,000 ft and 330 ft) above the landing location.



m² TANDEM meter



m² TANDEM feet

4.4 m² SPEED

The m² SPEED version is designated for canopy piloting. **This version is for the most experienced pilots with extremely fast parachutes and with great experience!** Activation occurs if the altitude above the landing area is below 270 m (885 ft) and the falling speed is over 45 m/s-1 (101 mph). The altitude lock is 450 m (1,475 ft). Activation will not occur under an altitude of 150 m (490 ft). Therefore, the activation zone is in the range between 270 m and 150 m (885 ft and 490 ft) above the landing location.



m² SPEED meter



m² SPEED feet

4. Safety device versions

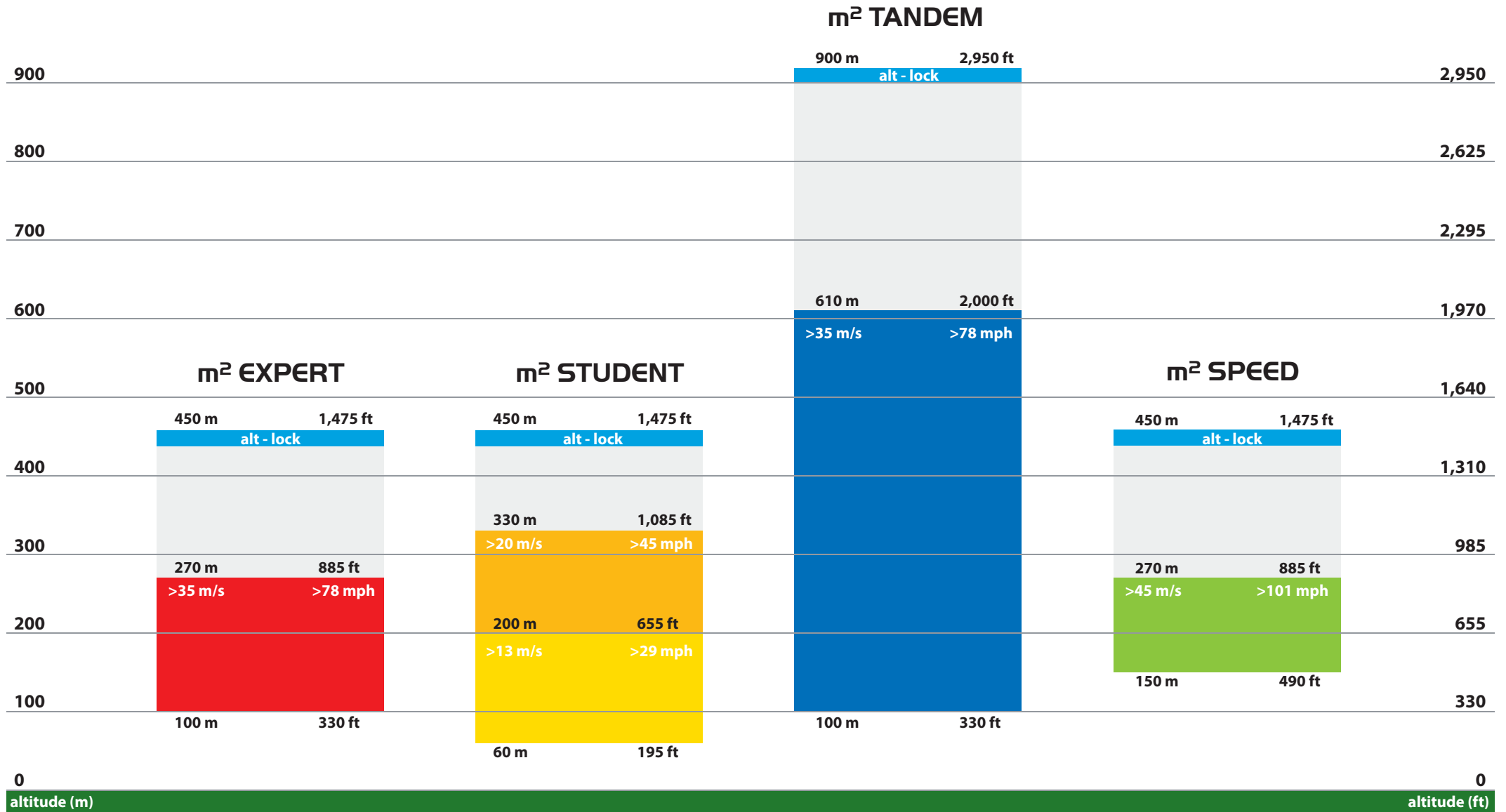

version	m ² EXPERT		m ² STUDENT		m ² TANDEM		m ² SPEED	
alt-lock	450 m	1,475 ft	450 m	1,475 ft	900 m	2,950 ft	450 m	1,475 ft
top	270 m	885 ft	330 m	1,085 ft	610 m	2,000 ft	270 m	885 ft
bottom	100 m	330 ft	60 m	195 ft	100 m	330 ft	150 m	490 ft
speed	>35 m	>78 mph	>13 m	>29 mph	>35 m	>78 mph	>45 m	>101 mph



5. Installation

Installation of AAD **m²** into containers made by various manufacturers can be performed **solely** by those persons with senior-master rigger certification, or a holder of a comparable equivalent according to the legislation of the individual countries where the **m²** is installed.

The **m²** **must be installed** only into the original set supplied by MarS and installed directly into the container by the harness manufacturer or, potentially, by an authorized rigger. The rigger must **always adhere to** compliance with the manual issued by the manufacturer of the container during installation of the cutter, cable lines, the **m²** body pouch, and the control units.

Alternatively, the safety device can be installed into sets of other manufacturers if the following conditions are met.

Prior to installation, check the device for any mechanical damage of the individual parts, including the cables, and ensure that the connector of the cutter is sufficiently inserted into the device body and secured with the retaining screw. Then switch the device on to check that everything is correctly installed, and switch it off again.

The **m²** device body must be inserted into the pocket sewn into the bottom part of the reserve parachute in a manner that ensures the cable outlets from the **m²** body are as close to the bottom part of the container as possible. Proper installation reduces cable strain due to the pressure from the reserve parachute being in a closed – packed container.

The cables of the **m²** safety device must be placed in a fixed order.

The thin cable of the cutter is always first. If the set for placing the **m²** is sewn in such way that upon inserting the **m²** device body into the pocket, the thin cable of the cutter is lower than the thick cable, wind the cable clockwise from the front view (if it is sewn higher, wind the cable counter-clockwise). The wound cable must be placed in the prepared area in such a way that ensures the cable lies as close to the bottom of the container as possible, and in the area fixed with Velcro straps.



5. Installation



The thick cable of the control unit is **always second and must be placed on the wound thin cable**. If the m² device body is placed in such a way that the thick cable is higher than the thin cable, wind the cable counter-clockwise from the front view. If the set and device are placed in the opposite direction, then it is the reverse.

Both folded cables are secured with the Velcro strap.



Avoid sharp bends, knots and mutual entanglement of cable while placing cables! Place the cables in such a way that they are loose enough to avoid tension between the individual parts of the device!

Adhere to minimum radius for cable winding $r = 25$ mm! Bending a strong cable can result in its damage and subsequent defective function of the m²!

Avoid pulling on the cables, particularly the control unit and the cutter.

5. Installation



Cables **must not** be placed in the pocket for the device body and, at the risk of cable damage, **must not** be even partially under the device body.

The cutter and the control unit location must comply with the harness manufacturer's manual so that in both cases at least minimum cable spacing is ensured. Cable spacing reduces the probability of the device being damaged after packing and during common use.

Carefully study the container manufacturer's manual prior to general installation.

For proper functioning of the m², the closing loop must be pulled through the cutter!!!

6. Control





6.1 Control Principals

To switch the m^2 to the STANDARD-mode, press the control unit button four short times. This also prevents accidental switching on or off. After the device is switched on, it remains functional for 14 hours, and then turns itself off, regardless of the situation it is in. When not using your parachute, we recommend manually switching the device off. This saves the battery. After the activation sequence is complete, the instrument performs a self-check and calibration of zero altitude. If a problem is detected, the device reports an error.

If you are switching the m^2 on into a mode where you need to specify the altitude, the UP-mode or DOWN-mode, the numerical value of the altitude is entered by the individual digits. Gradually enter the whole number from left to right, from highest to lowest denomination. The m^2 provides all of the digits from „0“ through „9“ for the given denomination, in sequential order. Press to select the value for the current denomination and it will move on to the next value for entering, until all denominations are entered. The following text provides examples of input in meters as well as in feet.

If the m^2 displays the entered value, the whole number will be displayed on the control unit by individual digits from left to right, always for the given number of places. The number starts and ends with the symbol „-“.

6.2 Switching the device on into STANDARD-mode

It is assumed the device is switched off. Shortly press the control button (2) on the control unit body (1). Upon the  icon being displayed (3) immediately press the control button a second time; the  icon will be displayed; immediately press the button a third time; when the  icon is displayed, immediately press the button for the fourth time. The flashing  icon will be displayed, which indicates the auto-test and pressure calibration are in progress. Upon completion, the  icon will be shown on the display (3).



The device is now on and preset to zero altitude – GROUND ZERO. If you fail to switch off the device, it will automatically switch off after 14 hours.

The button only requires a short press - click. Pressing must occur when the  icon appears on the display. If this switching frequency has not been properly completed, the device will return to the OFF mode. The sequence must be repeated in order to start the device.

Never switch the device on in an aircraft!!!

6. Control

6.3 Switching the device off

Quickly press the control button (2) on the control unit body (1). Upon the  icon being displayed (3) immediately press the button for a second time; the  icon will be displayed; immediately press the button for a third time; when the  icon is displayed, press the button for the fourth time. No icon will be displayed. The device is now off. If the switching-off sequence has not been completed, device will remain in ON mode.

6.4 Switching the device on into UP-mode





If the landing location is higher than the take-off location, it is necessary to reset the device for the altitude difference in advance. The **m²** allows for upward adjustments between 10 m to 990 m (10 to 2,990 ft). If your device is in the meter version, you will be entering three positions. If your device is in the feet version, you will be entering four positions. The last position is always zero. All positions must be entered, including the zeros in the initial positions, if those are zeros. If you enter all zeros, the memory will retrieve the value last used in the UP mode.

Example of the procedure in meters:



The take-off location, device activation and calibration before jumping are at an altitude of 450 m above sea level. The planned landing area after diving is at an altitude of 700 m above sea level. The elevation difference is $700 - 450 = 250$ meters.



Higher located landing area

First, switch off the **m²**. Shortly press the control button (2) on the control unit body (1). Upon the  icon being displayed (3) immediately press the button for a second time, the  icon will be displayed; immediately press the button for a third time, the  icon will be displayed; do not press anything now, wait. After a short time, the  icon will be displayed; Immediately press the button for the fourth time and the digits 0, 1, 2, ..., 8, 9 will sequentially show up on the display. Pressing the button upon digit 2 being displayed will preset 2 x 100m. Then the digits 0, 1, 2, ..., 8, 9 will again be displayed. Pressing the button upon digit 5 being on the display will add a further 5 x 10m. The display will show 0. Press the button and the setting is confirmed. The display will automatically sequentially show the icons "-""2" "5" "0""-" (four digits in the feet version) for your verification and the device will complete the auto-test

6. Control

and calibration – flashing icon . It will then display the  icon, notifying that the device is now preset for the higher landing altitude. If the height presetting sequence is not properly completed, the device will go back into the OFF mode. The accuracy of the entered value can be checked in the menu under the letter „c“ - Correction.

6.5 Switching the device on into DOWN-mode



If the landing location is lower than the take-off location, it is necessary to reset the device for the altitude difference in advance. The m^2 allows for upward adjustments between 10 m to 990 m (10 to 2,990 ft). If your device is in the meter version, you will be entering three positions. If your device is in the feet version, you will be entering four positions. The last position is always zero. All positions must be entered, including the zeros in the initial positions, if those are zeros. If you enter all zeros, the memory will retrieve the values last used in the DOWN mode.

Example of the procedure in feet:

The take-off location, device activation and calibration before jumping are at an altitude of 1,200 feet above sea level. The planned landing area after diving is at an altitude of 560 feet above sea level. The elevation difference is $1,200 - 560 = 640$ feet. Because the version in feet requires the entering of four positions, the initial zero has to be entered as well.



Therefore, because four positions need to be entered for the feet version, you will enter the number 0640.

First, switch off the m^2 . Shortly press the control button (2) on the control unit body (1). Upon the  icon being displayed (3) immediately

press the button for a second time, the  icon will be displayed; immediately press the button for a third time, the  icon will be

displayed; do not press anything now, wait. After a short time, the  icon will be displayed; and next, the  icon. Immediately press

the button for the fourth time and the digits 0, 1, 2, ... 8, 9 will sequentially show up on the display. Pressing the button upon digit 0 being displayed will preset 0×1000 ft. Then the digits 0, 1, 2, ... 8, 9 will again be displayed. Pressing the button upon digit 5 being on the display will add a further 6×100 ft. Then the digits 0, 1, 2, ... 8, 9 will again be displayed. Pressing the button upon digit 5 being on the display will add a further 4×10 ft. The display will show 0. Press the button and the setting is confirmed. The display will automatically sequentially show the icons “-” “2” “5” “0” “-” (three digits in the meter version) for your verification and the device will complete the auto-test and

calibration – flashing icon . It will then display the  icon, notifying that the device is now preset for the lower landing altitude.









If the height presetting sequence is not properly completed, the device will go back into the OFF mode. The accuracy of the entered value can be checked in the menu under the letter „c“ - Correction.



Lower located landing area

6. Control

6.6 Switching the device on into X-mode (Only for devices with firmware 2xxx and higher)

Shortly press the control button (2) on the control unit body (1). Upon the  icon being displayed (3) immediately press the button for a second time, the  icon will be displayed; immediately press the button for a third time, the  icon will be displayed; do not press anything now, wait. After a short time, the  icon will be displayed; next,  will be followed by  (the so-called x-mode). Immediately press the button for the fourth time. The device will complete the auto-test and calibration – flashing the  icon. Next, the  icon will be displayed, indicating the device is switched on in the X mode.

6.7 Information in the device memory - MENU

6.7.1 MENU display description

The m² retains information which is available to the user upon following the steps below. The following information can be found in the m2 memory.



Opening altitude of the last jump (in meters, 4 digits = 0000 to 9999m)
(in feet, 5 digits = 00000 to 99999 ft)

The opening altitude will not appear if the falling speed is not exceeded during a jump, such as in hop & pop, static line opening, etc.



The total number of dives during the device's operation (5 digits = 0–99999 jumps);

The number of jumps will increase by one each time the altitude lock is released, which already occurs in the airplane at an altitude of 450 m (1,475 ft) or 900 m (2,950 ft) above the take-off location during the ascent of the aircraft, regardless of whether the jump was actually performed.



Landing location correction (in meters, 3 digits = 000 to 999 m) (in feet, 4 digits = 00000 to 9999 ft)

6. Control

If the **m²** is switched into UP-mode or DOWN-mode, the entered preset altitude will show, otherwise, it will read zero.



Remaining battery in % (2 digits = 0 to 99%);

If the battery shows just 1%, as an example, do not worry, the battery still has enough reserve and you can use the device all day. 100% will be displayed only upon the first time the m2 is switched on by the manufacturer. If a flashing „**b**“ appears instead of arrows when switching on for calibration and the battery status is 0%, do not use the device!!!



Device serial number (6 digits = XXXXXX);



Device configuration and firmware version (6 digits = VUFFFF);

V = version

“1” - EXPERT

“2” - STUDENT

“3” - TANDEM

“4” - SPEED

U = units

“A” – device calibrated in meters

“F” – device calibrated in feet

FFFF = firmware version



Year and month of manufacture (6 digits = YYYYMM; Y = year, M = month);



GRAVITY index of the last jump (3 digits = 0–99.9%);

The GRAVITY index is the maximum falling speed of the last jump in the activation zone expressed in percentage, while 100% is the activation speed of the device version currently being used. After landing, the skydiver can check how close he got to the activation limit of the device

6. Control











during the flight on the parachute. This information is important mainly for CP (Canopy Piloting), when parachute pilots reach high speeds in minimum altitudes above the ground. A decision can be made according to this index, whether the EXPERT version is sufficient for the pilot or, for example, SPEED is needed. The same absolute falling speed will mean a different GRAVITY index in various versions of the device. 100% is for m² SPEED 45m/s (101 mph); for m² EXPERT and m² TANDEM, 35 m/s (78 mph); for m² STUDENT, 13 m/s (29 mph). **Be aware of these differences!**











 Atmospheric pressure in 0.1 hPa (5 digits = XXXXX) Example: digits 09867 mean pressure 986.7 hPa

6.7.2 Sequence to display MENU

Upon activating the m² as per chapter 6.1, the display will show icon  or  or  or , depending on the selected mode.

Shortly press the control button (2) on the control unit body (1). The  icon will be displayed; do not press anything now, wait.

After a short moment, a  icon will be displayed – immediately press the control button and successively the following icons will be displayed in the stated order (see chapter 6.4.1)         . By clicking on one of them, the values saved in the m2 memory under the selected icon will be displayed. Example:

Shortly press the control button (2) on the control unit body (1). The  icon will be displayed, and next icon , immediately press the control button and successively the following icons will be displayed in the stated order    , successively the following icons will be displayed     (according to chapter 6.4.1 it means that the remaining battery capacity is 99 %) and then the switched on device will be displayed . All values are shown only. Non of the values in the menu can be changed.

6. Control

6.8 QuickCard switch-on sequence



X-mode
 m² EXPERT → SPEED
 m² STUDENT → EXPERT
 m² TANDEM → N/A

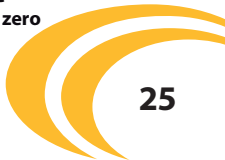
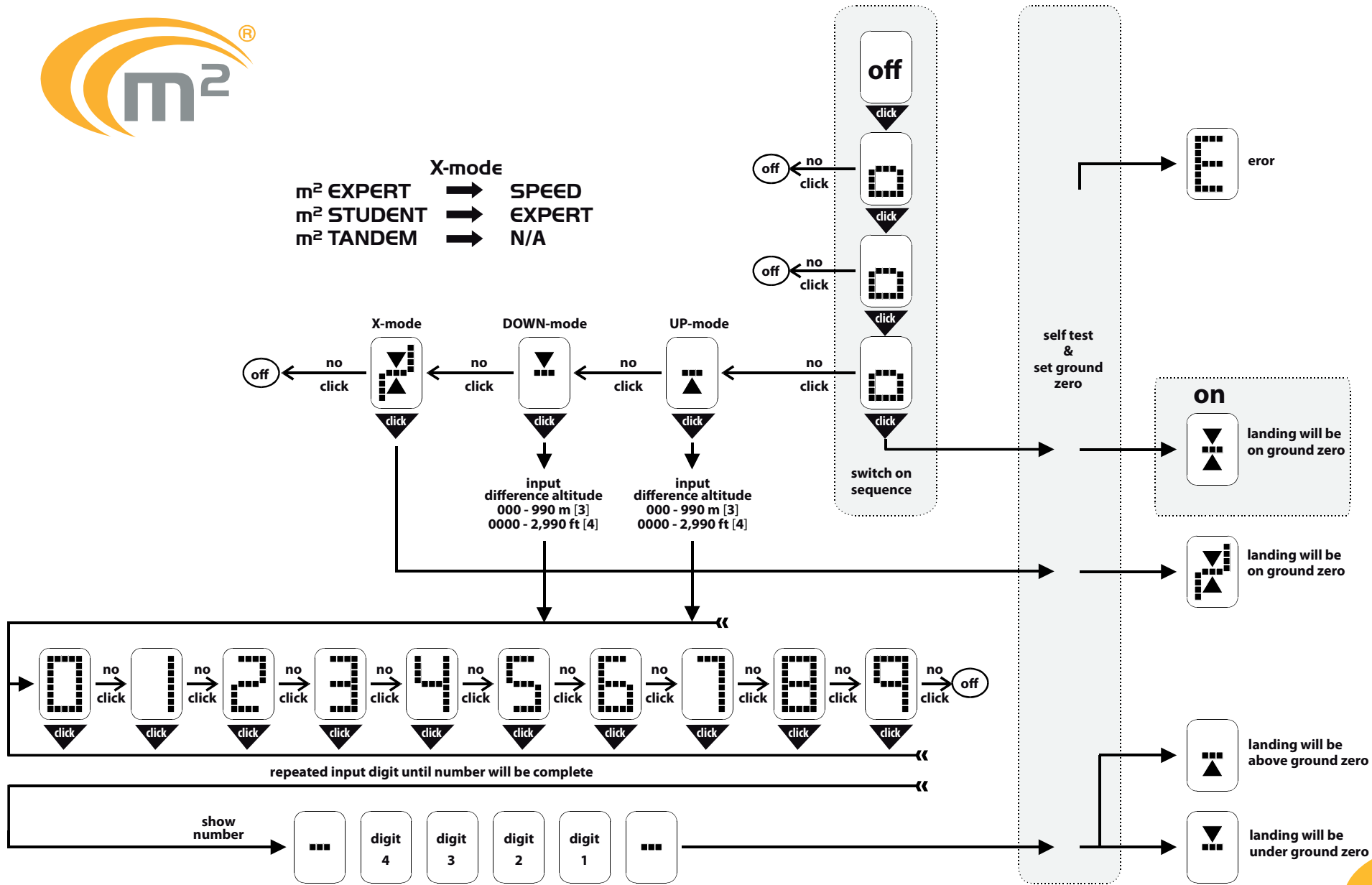

6. Control

6.9 QuickCard switch-off sequence

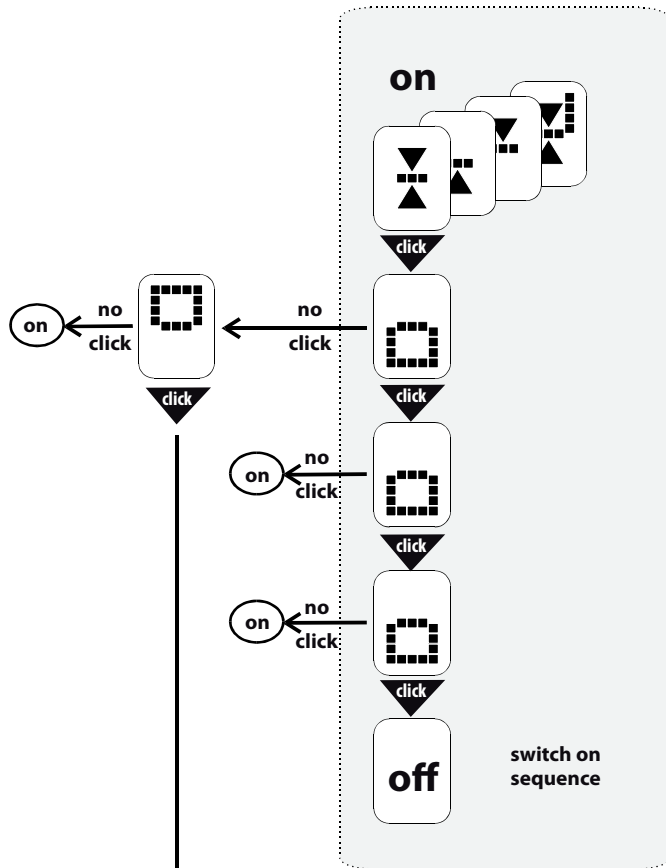

- d - last jump deploy altitude [4] 0000 - 9,999 m [5] 0000 - 99,999 ft
- J - total jumps counter [5] 99,999 jumps)
- c - correction altitude for next jump [3] 0 - 999 m [4] 0 - 2,999 ft
- b - remaining battery capacity [2] 99 - 0 %
- n - device serial number [6] XXXXXX
- H - settings & firmware version [6] VUFFFF
- Y - year and month of manufacture [6] YYYYMM
- G - gravity index of last dive [3] 0 - 99.9 %
- P - pressure [5] in 0.1 hPa

Configuration:

Version

„1“ m ² EXPERT	270 m (885 ft)	» 100 m (330 ft)	>35 m/s (>78 mph)	altitude lock 450 m (1,475 ft)
„2“ m ² STUDENT	330 m (1,085 ft)	» 60 m (195 ft)	>13 m/s (>29 mph)	altitude lock 450 m (1,475 ft)
„3“ m ² TANDEM	610 m (2,000 ft)	» 100 m (330 ft)	>35 m/s (>78 mph)	altitude lock 900 m (2,950 ft)
„4“ m ² SPEED	270 m (885 ft)	» 150 m (490 ft)	>45 m/s (>101 mph)	altitude lock 450 m (1,475 ft)

Unit

- „A“ meter
- „F“ feet

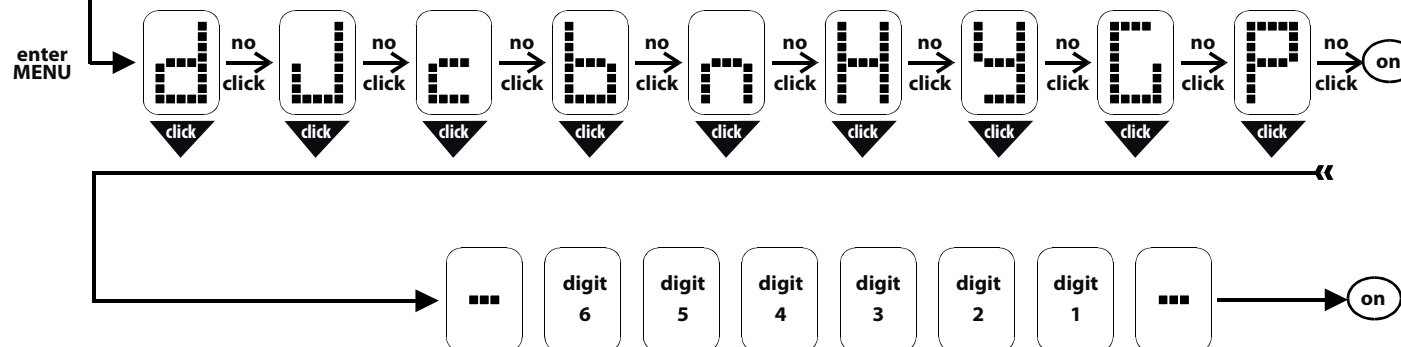

7. Maintenance

7.1 Cutter replacement

If the **m²** device has been activated, there are two ways in which the device can be again made functional:

- a) Performance of a device and cutter: complete the form included in the manual with a detailed description of the event (activation) and send the form, along with the entire **m²** device, to the address of either the manufacturer, MarS a.s. or an authorized dealer. The cutter will be replaced by the manufacturer or authorized dealer and the fully functional device will be sent back to the user within 14 days, at the latest, of having received the device.
- b) Replacement of the activated cutter performed by the user or rigger. To replace the cutter, the device must be switched off; the work should be done in a clean and dry environment, according to the instructions below.

With a TORX T8 screwdriver, release and completely unscrew the retaining screw (2) securing the connector (1) of the cutter (7) to the **m²** device body (4). Gently pull and turn the connector (1) in any direction and remove it completely.

Check that the connector area on the **m²** device body (4) is clean and whether the old 'O' sealing ring that was part of the original connector (1) is still in place.

Lubricate the "O" rings on the connector of the new cutter with silicone (7) (any silicone gel can be used, including silicone used for treating the closing lug on the reserve parachute - ATTENTION! – apply only a thin layer of silicone) and check that the 'O' sealing rings are correctly placed on the connector.

Insert the connector (1) of the new cutter (7) into the **m²** device body (4) by gently pressing and turning the connector (1) in any direction until the connector (1) is completely inserted into the **m²** device body (4).

Check for proper functioning of the whole **m²** device by switching it on.

If everything is correct, secure the connector (1) of the cutter (7) to the **m²** device body (4) with the retaining screw (4).

Just slightly tighten the locking screw. Never use excessive force if you have a problem loosening the screw. Cool the device in the freezer compartment, the contraction and expansion of various materials will loosen the screw.

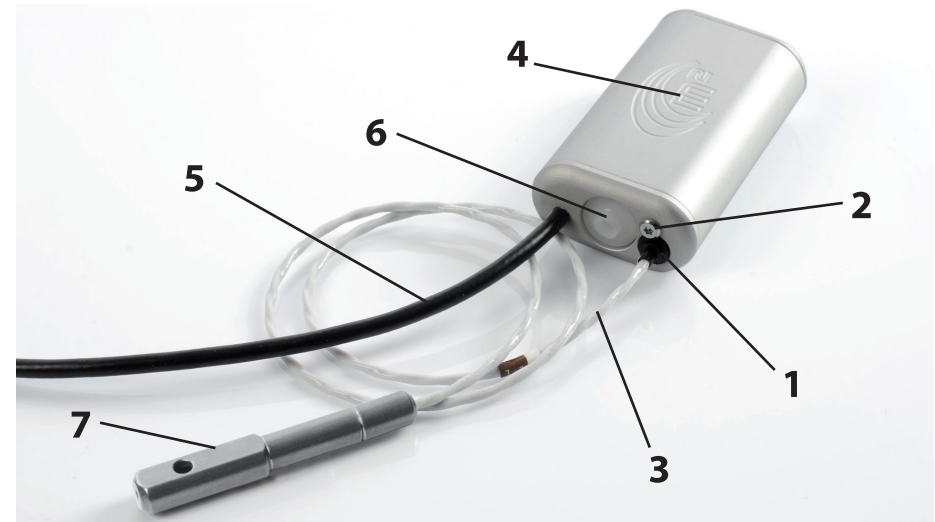

Never place the used cutter in an open fire or common waste. The cutter remains under pressure!

7. Maintenance

7.2 Filter Replacement

After contact with water, it is necessary to replace the air filter which is built into the **m²** body. The filter serves as a pressure sensor providing protection against contamination. Never use or store the **m²** device without a filter.

It is necessary to complete the following tasks upon the device having made contact with water: Immediately switch the **m²** device off and remove it from the container. Rinse the **m²**, including the cables, several times in clean lukewarm water. Dry the entire device; hang it by the metal body (4). Let the cables hang (3 and 5) loosely and let the device dry in the air. Remove the old plastic filter (6) with the use of a small screw driver or pliers. Insert the screw driver directly into the filter centre (6) and, regardless of filter damage, remove the old filter (6) by pulling it from the device body (4). Check the filter area (6) for any impurities and, if clean, completely insert a new filter (6). The filter (6) must be fully inserted – press firmly applying great pressure, until it is completely buried in the **m²** device body (4). Only the entry filter tube exceeds the outline of the device body.



Switch on the device and check its function. Dispose of the filter in common waste or with plastic recycling waste.

Upon the **m² device having made contact with water, the filter must always be replaced, even if the device appears to be functioning properly upon drying!**

7.3 Battery

The **m²** device is designed to last its total lifetime without the need for battery replacement. If for any reason the battery fails during the device's lifetime, it must be replaced by the manufacturer.

If the battery shows just 1%, as an example, do not worry, the battery still has enough reserve and you can use the device all day. 100% will be displayed only the first time the **m²** is switched on by the manufacturer. If a flashing „b“ appears instead of the arrows when switching on during calibration and battery status is 0%, do not use the device!!!

7. Maintenance

7.4 Yearly Inspection

The manufacturer requests that inspection of the **m²** device be performed at least once every calendar year, either by the user or a rigger. The user is always responsible for this inspection and it is up to them whether the required tasks are performed on their own or entrusted to someone else. We recommend an inspection be done during repackaging of the reserve parachute.

Inspection Procedure:

Visually inspect the device for any apparent mechanical damage, especially that there is no damage on the connection cables, filter, control unit and cutter.

Check the battery (under the letter „**b**“ in the device MENU).

Check the displayed pressure (under the letter „**P**“ in the device MENU).

Check the altitude lock release in the aircraft during ascent.

Perform pressure check by comparing to another precision instrument that shows barometric pressure.

Announced actual pressure at the airport can also be used. Variance must not be more than +/-15 hPa.

Check the altitude lock release in the aircraft during ascent to verify whether the device really works and reacts to the aircraft ascent.

Check the altitude lock release at 450 m (1,475 ft) or 900m (2,950 feet) with another altimeter. The altitude lock is released when the center line between the arrows disappears.

8. Securing closing loop in washer

8.1 Variation 1

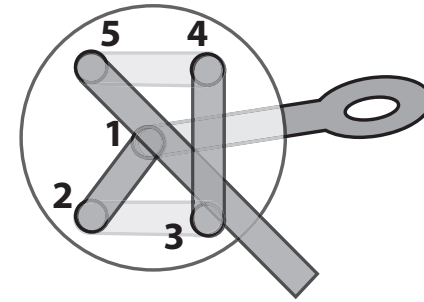
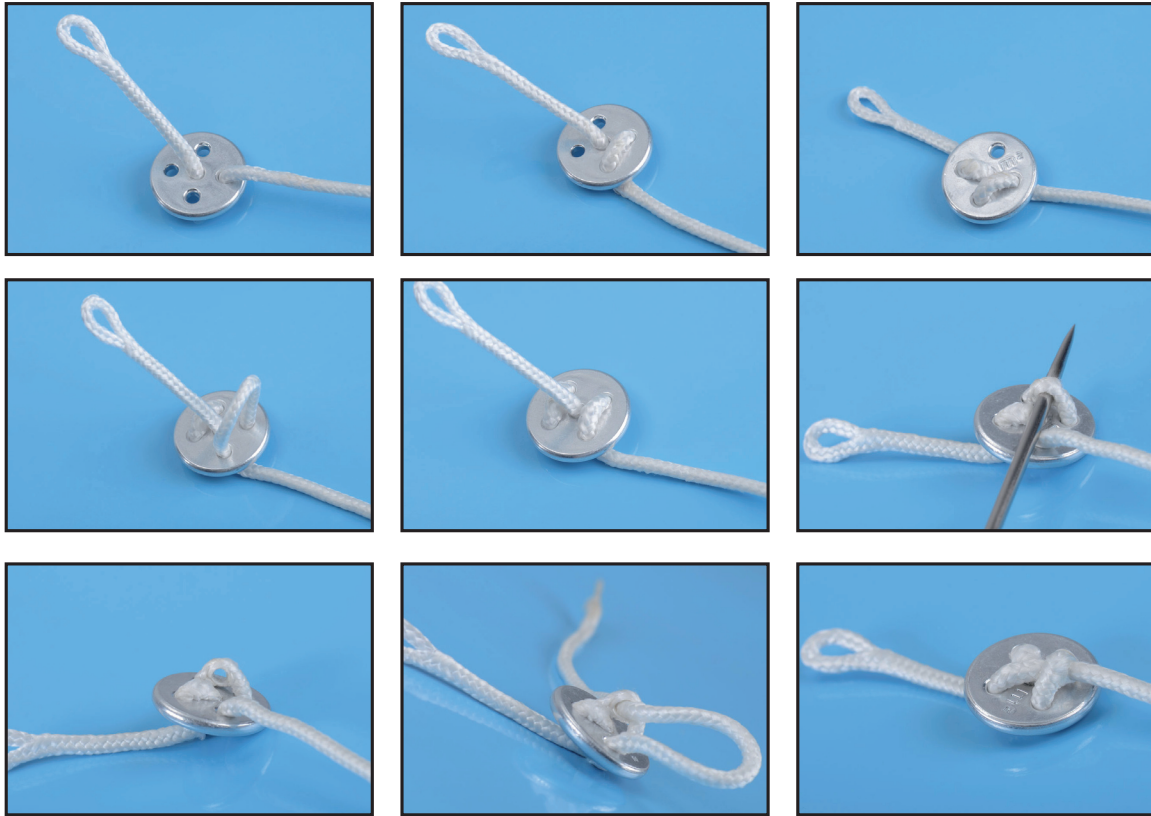

8.2 Variation 2

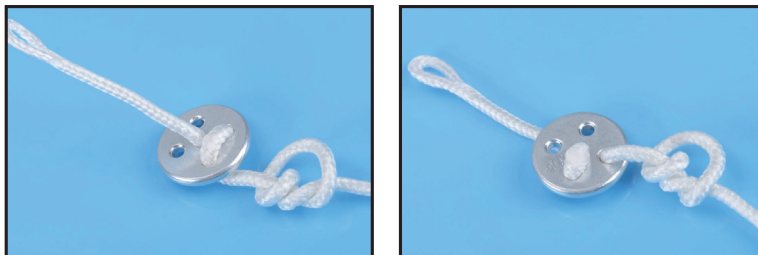

9. Error Reports

Error reports will be displayed on the device with the  „ERROR“ icon. If this icon appears on the display of the control unit, the **m²**

must not be used for diving until the defect-failure is resolved. In order to discover the type of error, proceed as follows: Quickly press the control button (2) on the control unit body (1). The display (2) will show the error number in the form of this example:

. Digit 2 specifies the type of error-defect.

If the  „FAILURE“ icon appears on the display, the device will be disabled and it is not possible to switch it on or off. It must be sent to the manufacturer for service.

Review of errors as per digit indication:

 Internal integration error.
Solution: Send your device to the manufacturer for repair.

 Calibration error to GROUND ZERO. The range of measured values is too large or the calibration value is out of limits.
Solution: Switch the **m²** off and on, the calibration will be completed again.

 Cutter error. The cutter is incorrectly connected, used or damaged.
Solution: Check the cutter; potentially replace the cutter with a new one.

 Low battery voltage.
Solution: If the error appears repeatedly, do not use the device. Contact the dealer, distributor or manufacturer.

 Pressure sensor error, or out-of-range value.
Solution: Switch the **m²** off and on again. In case of repeated error, do not use the device and contact the dealer, distributor or manufacturer.

If the specified error reports are not successfully resolved or you are not sure how to solve the problem, contact the dealer, distributor or manufacturer.

10. Technical Data

10.1 Basic Technical Data

Total weight	approx. 220 g
Length, width, height of processing unit	approx. 85 mm x 45 mm x 23 mm
Length, width, height of control unit	approx. 63 mm x 18 mm x 5 mm
Thickness, length of cutter	approx. thickness 8 mm x length 66 mm
Cable length of control unit	approx. 660 mm
Cable length of cutter	approx. 500 mm
Working temperature (inside device)	from 4°F (-20°C) to 131°F (+55°C)
Storage temperature (Recommended)	from 41°F (+5°C) to 77°F (+25°C)
Waterproof	24 hours in depths up to 2 m (6.5 ft)
Altitude adjustment of landing area (AGL)	+/- 990 m (+/- 2,990 ft)
Functioning period	14 hours from switch on
Lifetime	15 years, 5,000 flight hours or 15,000 jumps (20 minutes per jump)
Operating range below / above sea level	-500 m to +8,000 m (-1,640 ft to +26,200 ft)

10.2 Total Lifetime of m² and Batteries

The total lifetime of the AAD m² is 15 years or a total of 5,000 flight hours, which is approximately 15,000 jumps (a jump is considered to be a maximum of 20 minutes from start-landing).

Upon the final assembly and complete function testing of each m² device, the device remains fully functional, including the actual deduction of battery capacity. If a new m² device displays an actual battery capacity (menu letter „b“) of 99% during inspection, it is an accurate reading, which **DOES NOT AFFECT THE TOTAL SPECIFIED SERVICE LIFE** of the m² device.

The m² device allows actual capacity in % to be displayed in order to enable simple inspection. As long as the battery capacity is over 0%, the m² device will always provide reliable function. Upon reaching zero capacity, upon activation during calibration the device will display a flashing icon with the letter „b“ (battery), the device will still be functional.

Never use the m2 device with 0% battery capacity!!!

10.3 Cutter Lifetime

The total cutter lifetime is 16 years from the manufacture date. The cutter is marked with the year of manufacture and batch code. Never use a cutter with expired lifetime.

II. Important principles

- The device must be switched on at the GROUND ZERO landing location or at take-off location; never in an airplane or other airborne transportation.
- The unit is functional (armed) upon the altitude lock release at a height of 450 m (1,475 ft) for the **m² STUDENT** and the **m² EXPERT**, or 900 m (2,950 ft) for the **m² TANDEM**. The center line between the arrows on the display will disappear.
- Airborne aircraft must not descend below the landing location altitude plus 40 m (130 ft), once it has already exceeded this altitude.
- If a jump was abnormally long, more than 1.5 hours, switch the device off and on again.
- If you land outside the airport, or if leaving the airport to later return, switch the device off during any transport, and back on again before the next jump.
- If you accidentally land at a place situated approximately 30 m (100 ft) higher or lower than the selected landing area, switch the device off after landing and turn it back on before the next jump.
- Maintain a safe altitude to open the main parachute. Avoid dropping into the activation zone. Avoid the risk of opening the reserve parachute along with the main one.
- For failure-free operation of the system, having the correct pilot parachute according to the manufacturer's packaging is necessary. The closing loop must be stretched by a force of at least 50 N.
- When using a performance parachute, check the GRAVITY index.
- When aborting a jump, switch off the **m² STUDENT** device before descent. An aircraft can easily reach speeds of over 13 m / s (29 mph) (2,500 ft/min) when landing.
- Avoid proximity to sources of powerful electromagnetic radiation, such as radar, GSM transmitters, radios, etc.

12. Warranty

All the parts used in the **m²** device, and its total correct function as per the specified limits, are covered by the manufacturer's 24-month warranty, valid from the date of purchase.

The warranty does not cover damages occurring from common use of the **m²** device, incorrect installation, or non-standard and rough handling. The manufacturer reserves the right to decide whether to repair or replace the unit.

13. X-RAY card

To Airport Security Personnel:

The device **m²** is parachute emergency opening system for reserve parachute. The **m²** is a life saving device for skydivers. Display on the screen (X-ray) may be different depending on the parachute container. All parts of device are not subject to any transport regulations. The **m²** parts:

1. central unit, 2. control unit, 3. cutter, 4. control unit cable, 5. cutter cable

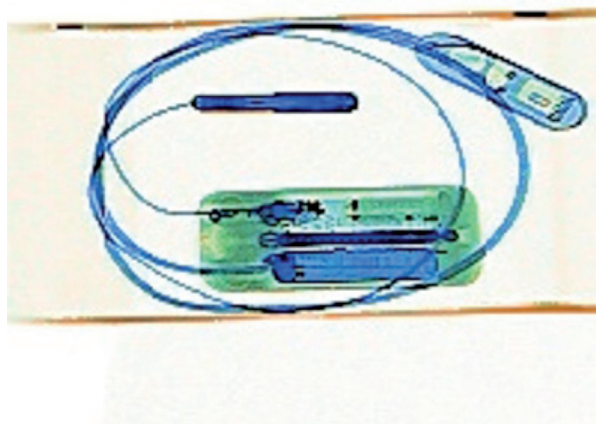
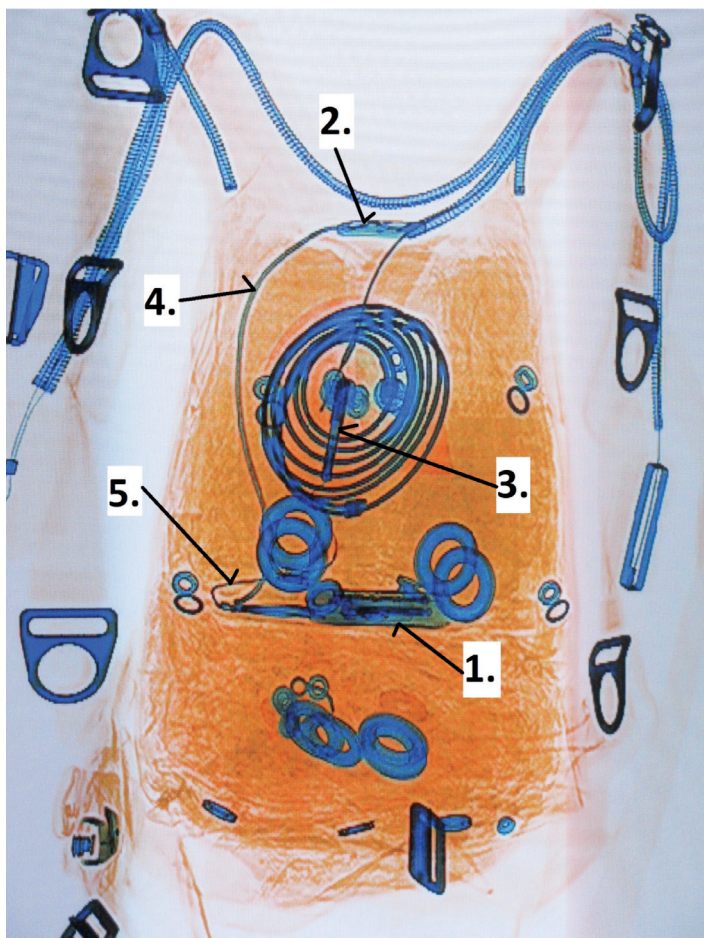

X-ray card

Packed in a box

MarS a.s., Okružní II 239
569 43 Jevicko, Czech Republic
mars@marsjev.cz
phone +420 461 353 841
www.m2aad.com
www.marsjev.com

14. Disclaimer

The MarS a.s. dedicated great care and attention to the development, laboratory testing, field testing and m² device properties. The goal was, and still is, to provide users with maximum comfort and especially security in the use of the safety devices. All efforts are directed to the cutter reliably cutting the closing loop of the reserve parachute when meeting the activation criteria.

Although the device will function properly when used, it does not guarantee the functioning of the other parts of the parachute rig. The device itself does not exclude the possibility of serious injury or even death. In certain non-standard situations, the device itself can be the cause of death. The device is only one of the ways to increase the likelihood of solving critical situations the user may encounter while skydiving. Never rely solely on the security device. The basics of a safe jump are quality training, compliance with safety rules, relevant health, mental ability, quality equipment from authorized manufacturers and the adoption of procedures for dealing with emergency situations. Only by meeting these conditions can the likelihood of the safety device to solve emergency situations be increased, if such should occur.

The safety device (AAD) is an electronic device and, like any other electronic device, may not always work properly, even providing that it is properly installed and used. Using the appliance only reduces the risk of injury or even the death of the user. Should the user still choose to use the device or put the unit at the disposal of another person to use, this act confirms they are aware of these risks and the potential consequences associated with the use of the device. Even a properly functioning device may cause serious injury or death!!!

By using the device, the user commits to use it as delineated in this manual. The manufacturer assumes no liability for damages arising from failure to follow the delineated procedures.

The manufacturer MarS a.s. assumes no responsibility for any failures and any damages or consequences resulting from these failures. If the user is not willing to accept these facts, the manufacturer recommends they not use the device.